

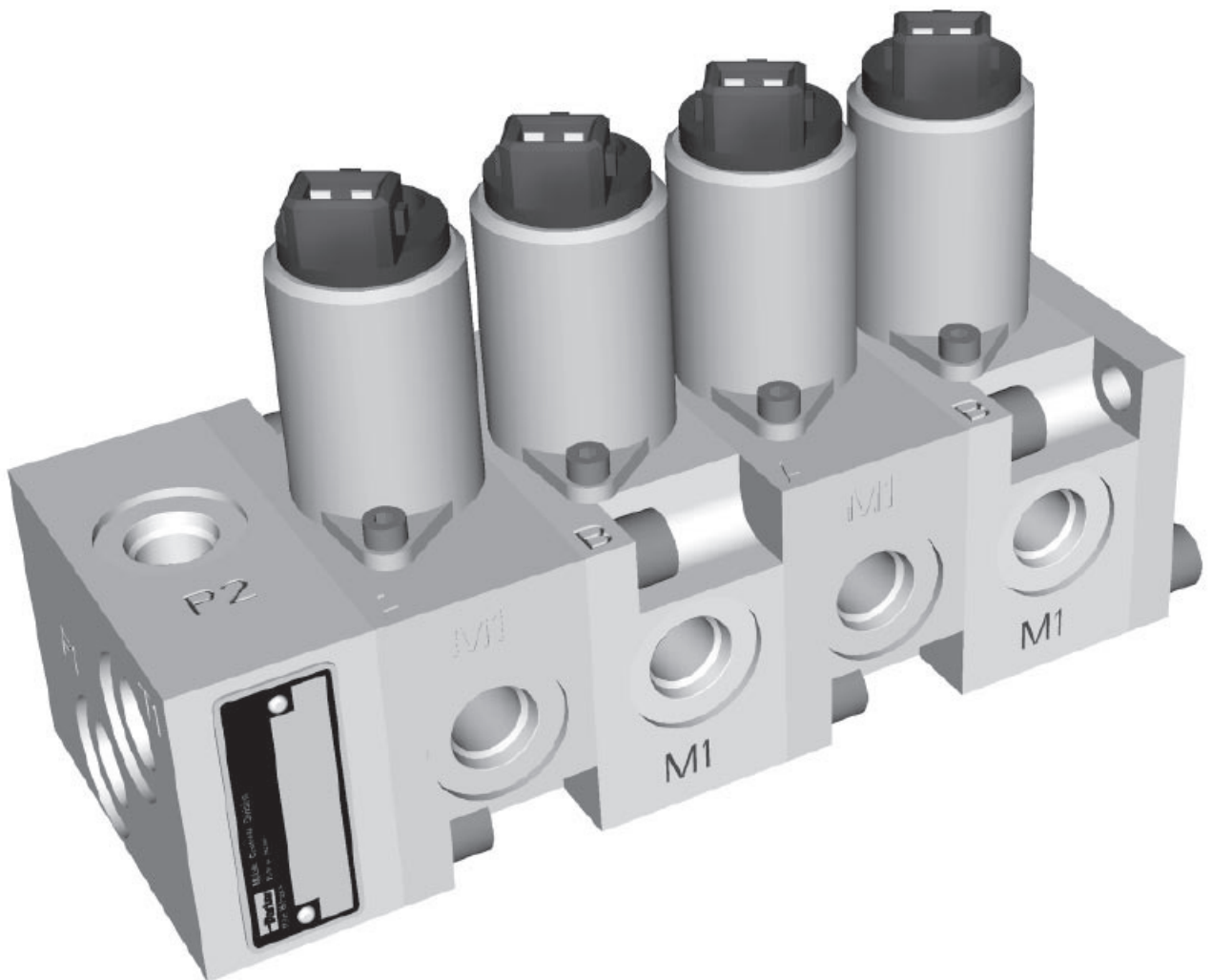

Proportional Remote Control Valves Series PVC6

December, 2007



Proportional Pilot Remote Valve PVC6

Series PVC6 is a bankable valve assembly used for remote control of directional control valves. The proportional pressure reducing valve creates a pressure proportional to the inlet current. Solenoid Coil Voltage is available in 12 or 24 Volt. The inlet section can be equipped with a pressure reducing valve to protect the control sections (max inlet pressure to control section is 50 bar).

General

Filtration to reach Target Contamination Class 16/13 according to ISO 4406 is recommended. The best performance is obtained if mineral-base oil of high quality is used. Hydraulic fluids of type HLP (DIN 51524), oil for automatic gearboxes Type A and engine oil type API CD can be used. Synthetic, fire-resistant and environmentally friendly oils can also be used. Oil temperature range for function -20 to 90 °C.

**Inlet Section
with Pressure Reducing Valve**

Max inlet pressure	350 bar
Max reduced pressure setting	50 bar
Max flow	30 l/min
Drain flow	0.4 l/min
Port dimensions P1, P2, PRM and T1	
BSP ¼ or 9/16-18 UNF	

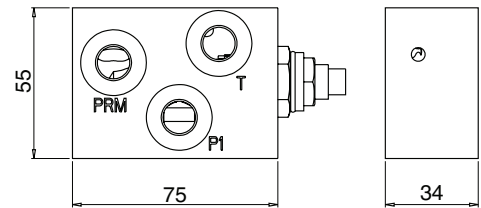
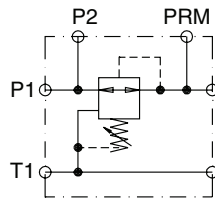

**Inlet Section
without Pressure Reducing Valve**

Max inlet pressure	50 bar
Port dimensions P1, P2 and T1, T2	
BSP ¼ or 9/16-18 UNF	

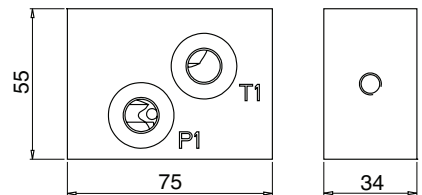
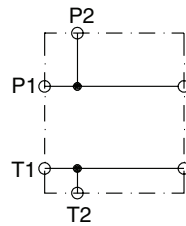

Control Section

Max inlet pressure	50 bar
Max flow	3 l/min
Control current for PVC25	12 volt
Starting (5 bar)	570 mA
Fully actuated (25 bar)	1450 mA
Control current for PVC25	24 volt
Starting (5 bar)	290 mA
Fully actuated (25 bar)	750 mA

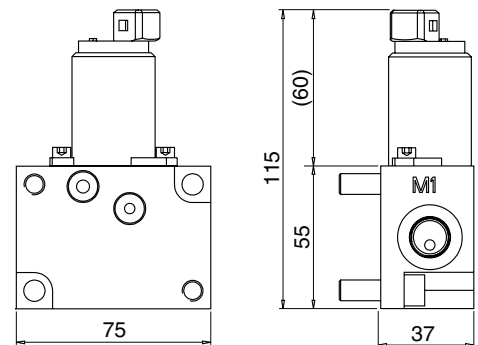
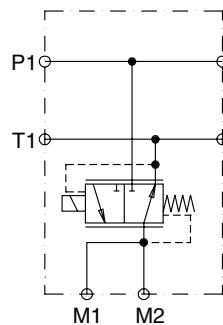

Port dimensions M1 M2
BSP ¼ or 9/16-18 UNF

End Section

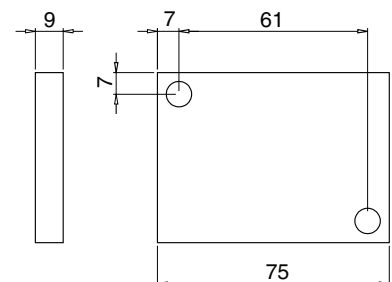
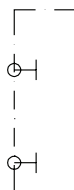

Single Control Section

If more than 6 sections are needed, single sections can be ordered and assembled onto the system. The single section is complete with screws and o-rings. There are 4 types of sections that have to be used.

Ordering code: BSP-ports

12 Volt (odd section)	3767 035
24 Volt (odd section)	3767 036
12 Volt (even section)	3767 039
24 Volt (even section)	3767 040

Ordering code: UNF-ports

12 Volt (odd section)	3767 037
24 Volt (odd section)	3764 038
12 Volt (even section)	3767 034
24 Volt (even section)	3767 042

Remote Control Assemblies

Following assemblies are available.

Ordering code: BSP-ports

12 Volt with pressure reducing valve

1 section	3770539
2 sections	3767043
3 sections	3770540
4 sections	3767044
5 sections	3770541
6 sections	3767045

Ordering code: UNF-ports

12 Volt with pressure reducing valve

1 section	3770542
2 sections	3767046
3 sections	3770543
4 sections	3767047
5 sections	3770544
6 sections	3767048

24 Volt with pressure reducing valve

1 section	3770545
2 sections	3767049
3 sections	3768848
4 sections	3767050
5 sections	3770547
6 sections	3767051

24 Volt with pressure reducing valve

1 section	3770548
2 sections	3767052
3 sections	3770549
4 sections	3767053
5 sections	3770550
6 sections	3767054

12 Volt without pressure reducing valve

1 section	3770551
2 sections	3767055
3 sections	3770552
4 sections	3767056
5 sections	3770553
6 sections	3767057

12 Volt without pressure reducing valve

1 section	3770554
2 sections	3767058
3 sections	3770555
4 sections	3767059
5 sections	3770556
6 sections	3767060

24 Volt without pressure reducing valve

1 section	3768535
2 sections	3767061
3 sections	3770558
4 sections	3767062
5 sections	3770559
6 sections	3767063

24 Volt without pressure reducing valve

1 section	3770560
2 sections	3767064
3 sections	3770561
4 sections	3767065
5 sections	3770562
6 sections	3767066

Dimensional Drawing

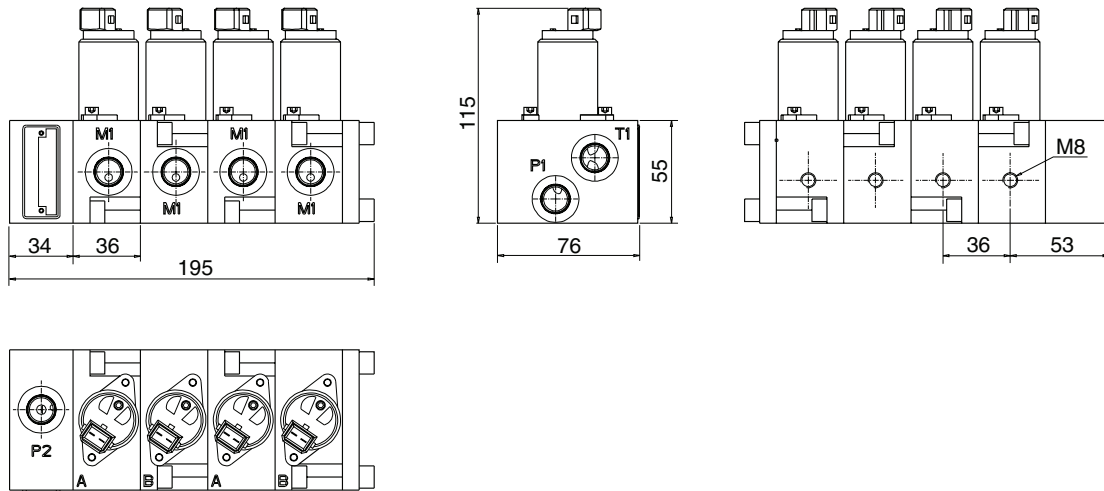

Split View

